

Data sheet | Item number: 2092-1127

1-conductor female plug; 2.5 mm²; Pin spacing 5 mm; 7-pole; 2,50 mm²;
light gray

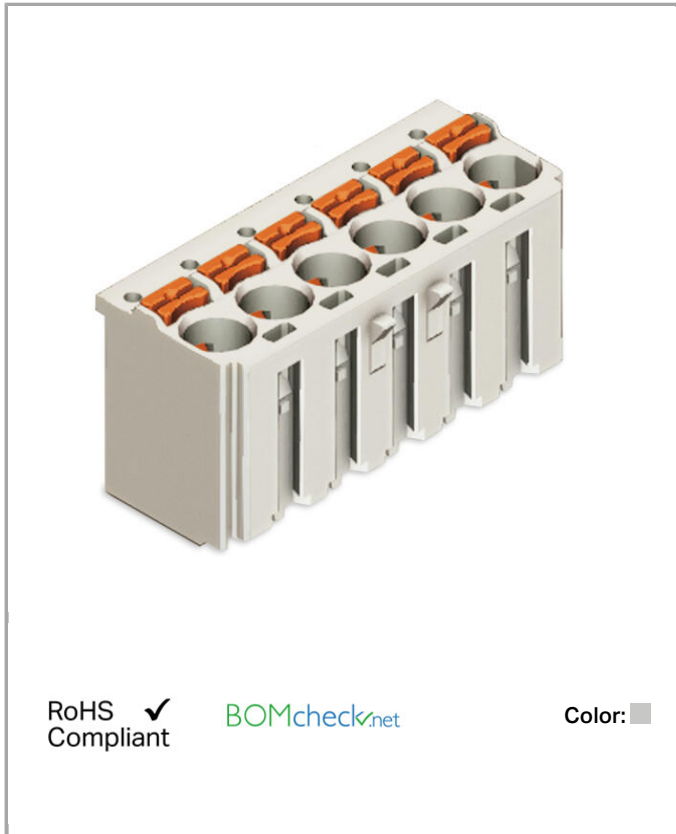

2092-1127



RoHS Compliant

[BOMcheck.net](https://www.bomcheck.net)

Color:

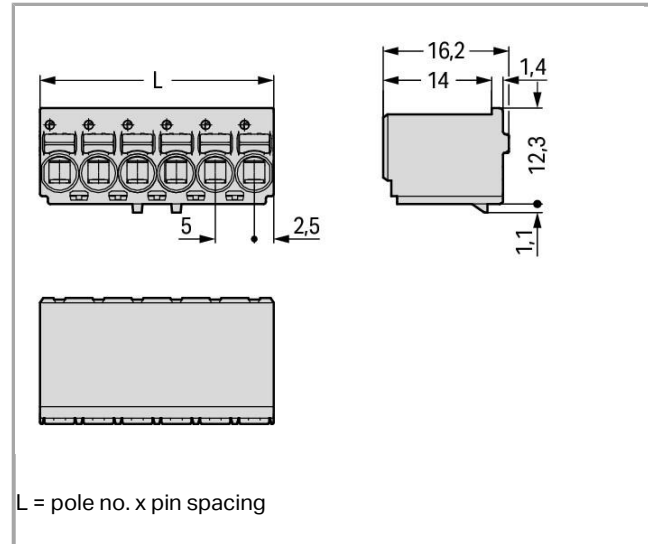

Item description

- Universal connection of all conductor types
- Simple, push-in termination of solid and ferruled conductors
- Easy-to-use design does not require special tools
- Ability to wire while mated or unmated
- Testing parallel to conductor entry – tip contact
- Also available with gripping plates
- Integrated locking latches prevent accidental disconnection

Safety information 1:

The **picoMAX[®] pluggable connection system** is designed without breaking capacity for compliance with DIN EN 61984. When used as intended, MCS Connectors shall not be connected/disconnected when live or under load. The circuit design should ensure header pins, which can be touched, are not live when unmated.

Data

Electrical data

Ratings per IEC/EN 60664-1

Rated voltage (III / 3)	250 V
Rated impulse voltage (III / 3)	4 kV
Rated voltage (III / 2)	320 V
Rated impulse voltage (III / 2)	4 kV
Rated voltage (II / 2)	630 V
Rated impulse voltage (II / 2)	4 kV
Rated current	16 A

Approvals per UL 1059

Rated voltage UL (Use Group B)	300 V
Rated current UL (Use Group B)	15 A
Rated voltage UL (Use Group D)	300 V

Connection data

Connection technology	Push-in CAGE CLAMP®
Actuation type	Push-button
Solid conductor	0.2 2.5 mm ² / 24 12 AWG
Fine-stranded conductor	0.2 2.5 mm ² / 24 12 AWG
Fine-stranded conductor with ferrule with plastic collar	0.25 1.5 mm ²
Fine-stranded conductor with ferrule without plastic collar	0.25 2.5 mm ²
Strip length	9 10 mm / 0.35 0.39 inch
Total number of connection points	7
Total number of potentials	7
Number of connection types	1
Number of levels	1
No. of poles	7

Geometrical Data

Pin spacing	5 mm / 0.197 inch
Width	35 mm / 1.378 inch
Height	16.2 mm / 0.638 inch
Depth	13.4 mm / 0.528 inch

Plug connection

Contact type (pluggable connector)	Female connector/socket
Connector connection type	for conductors
Mismating protection	No

Material Data

Color	light gray
Material group	I
Insulating material	Polyphthalamide (PPA GF)
Flammability class per UL94	V0
Clamping spring material	Chrome nickel spring steel (CrNi)
Contact material	Electrolytic copper (E _{Cu})
Contact plating	tin-plated
Fire load	0.149 MJ
Weight	6.44 g

Environmental Requirements



Limit temperature range	-60 +100 °C
-------------------------	-------------

Commercial data



Product Group	26 (picoMAX)
Country of origin	DE
GTIN	4050821821625
Customs Tariff No.	85366990990

Approvals / Certificates

Country specific Approvals

Logo	Approval	Additional Approval Text	Certificate name
	CB DEKRA Certification B.V.	IEC 61984	NL-49737
	CSA DEKRA Certification B.V.	C22.2	2362521
	KEMA/KEUR DEKRA Certification B.V.	IEC 61984	71- 102261

UL-Approvals



Logo	Approval	Additional Approval Text	Certificate name
	cURus Underwriters Laboratories Inc.	UL 1059	E45172
	UR Underwriters Laboratories Inc.	UL 1977	20170428- E45171

Compatible products

check

	Item no.: 735-500 Test pin; 1 mm Ø; with solder connection for test wire	735-500
--	---	---------

tools

	Item no.: 2092-1630 Unlocking tool; orange	2092-1630
	Item no.: 210-719 Operating tool; Blade: 2.5 x 0.4 mm; with a partially insulated shaft	210-719

Strain relief plate

	Item no.: 2092-1602 Gripping plate; light gray	2092-1602
	Item no.: 2092-1602/002-000 Gripping plate with sliding connector release; light gray	2092-1602 /002-000

Downloads

Documentation

Additional Information

Technical explanations	Apr 3, 2019	pdf 3.6 MB	Download
------------------------	-------------	---------------	----------

Product family

picoMAX
[Show all products from the family](#)



Subject to changes.
